



Since 1947

*INSTALLATION,
OPERATION
AND
MAINTENANCE
MANUAL*

**SUCTION HEATER
KIT**

PROCESS HEATING COMPANY, INC.

POST OFFICE BOX 84585

SEATTLE, WASHINGTON 98124-5885

PHONE: (206) 682-3414 FAX: (206) 682-1582

WARNINGS

- 1) READ AND UNDERSTAND ALL TAGS AND INSTALLATION AND OPERATING INSTRUCTIONS BEFORE COMMENCING.
- 2) CHECK THAT THE ELECTRICAL SERVICE WILL HANDLE THE LOAD. UNIT MUST BE ADEQUATELY GROUNDED.
- 3) ALL WIRING SHOULD CONFORM TO REQUIREMENTS OF NATIONAL AND LOCAL ELECTRICAL CODES AND STANDARDS.
- 4) ONLY LICENSED ELECTRICIAN SHOULD CONNECT POWER TO PANEL AND SYSTEM.
- 5) NEVER EXPOSE HEATER TUBES TO AIR WITH POWER ON.
- 6) CARE SHOULD BE USED WHEN WORKING AROUND TUBES WHEN CLEANING OR INSTALLING. WALLS ARE LESS THEN ¼" THICK.
- 7) IF THERE ARE ANY QUESTIONS CONCERNING THE RATINGS OR INSTRUCTIONS PLEASE CONTACT YOUR LOCAL DISTRIBUTOR OR THE FACTORY. PHONE (206) 682-3414 FAX (206) 682-1582

ADDITIONAL IMPORTANT INFORMATION

- 1) THESE INSTRUCTIONS CANNOT POSSIBLY COVER EVERY SITUATION CONCERNING THE OPERATION, INSPECTION, ADJUSTMENT AND TEST OF THE EQUIPMENT FURNISHED. PROCESS HEATING COMPANY (PHCo), IN THE FURNISHING OF THIS EQUIPMENT AND THESE INSTRUCTIONS, MUST PRESUME THAT THE OPERATING AND MAINTENANCE PERSONNEL USING THIS EQUIPMENT HAVE SUFFICIENT TECHNICAL KNOWLEDGE AND EXPERIENCE TO APPLY SOUND SAFETY AND OPERATIONAL PRACTICES WHICH MAY NOT BE MENTIONED.
- 2) IN APPLICATIONS WHERE PHCo FURNISHED EQUIPMENT THAT IS TO BE INTEGRATED WITH A PROCESS OR OTHER EQUIPMENT, THESE INSTRUCTIONS SHOULD BE THOROUGHLY REVIEWED TO DETERMINE THE PROPER INTEGRATION OF THE EQUIPMENT INTO THE OVERALL PLANT OR SYSTEM OPERATIONAL PROCEDURES.
- 3) PHCo DOES NOT SUPPLY, RECOMMEND OR APPROVE THE VARIOUS SYSTEMS IN WHICH ITS PRODUCTS ARE OR MAY BE USED. UNLESS DESIGNED, MANUFACTURED AND USED PROPERLY, VARIOUS SYSTEMS MAY BE INHERENTLY UNSAFE OR DANGEROUS. THE USER SHOULD CHECK AND COMPLY WITH ALL FEDERAL, STATE AND LOCAL REGULATIONS AND OTHER REGULATIONS AND RECOMMENDATIONS SUCH AS: NFPA, UL, API, OSHA, ETC.

PREPARATION

- 1) REMOVE JACKETING AND INSULATION FROM SECTION OF TANK HEATER IS TO BE INSTALLED THROUGH.
- 2) MARK LOCATION OF OPENING ON TANK. HEATER SHOULD BE KEPT AS LOW AS POSSIBLE IN TANK.

CAUTION

BEFORE BURNING OR WELDING ON TANK, CLEAN THOROUGHLY AND KEEP WELL VENTILATED.

INSTALLATION

- 1) BURN OPENING IN TANK SLIGHTLY LARGER THAN HEATER MOUNTING RING (SNUG FIT). REMOVE SLAG AND GRIND OPENING SMOOTH.
- 2) HEATER MUST BE MOUNTED HORIZONTAL AND SECURELY TO SUPPORT THE WEIGHT OF THE HEATER AND FLUID INSIDE.
- 3) REMOVE BLOCKING AND SUPPORT PLATE(S) AND SLIDE HEATER THROUGH OPENING IN TANK. STOP AT MARKED "WELD LINE" ON HEATER TERMINAL BOX.
- 4) WELD HEATER MOUNTING RING TO TANK. RING IS ¼" THICK STEEL. WELD MUST BE LIQUID TIGHT.
- 5) CONNECT PIPING TO INLET AND OUTLET FITTINGS ON VESSEL. OUTLET IS AT TOP OF VESSEL.
- 6) HAVE LICENSED ELECTRICIAN CONNECT PROPER VOLTAGE AND PHASE TO THE LINE SIDE OF THE MAIN DISCONNECT SWITCH USING SUITABLE WIRE GAUGE FOR HEATER LOAD. UNIT MUST BE PROPERLY GROUNDED.
- 7) CHECK ALL CONNECTIONS TO INSURE THEY ARE ALL TIGHT SINCE VIBRATION IN TRAVEL CAN LOOSEN WIRE CONNECTIONS.

OPERATION

- 1) TURN ON THE MAIN DISCONNECT SWITCH.
- 2) PUSH THE RED HIGH LIMIT RESET PUSHBUTTON TO PULL IN THE CONTACTOR AND PROVIDE LOAD POWER.
- 3) THE INDICATING TEMPERATURE CONTROL (IN ENCLOSURE DOOR) SHOULD BE SET TO DESIRED PROCESS TEMPERATURE BY PRESSING UP/DOWN ARROWS AND THEN PRESSING ENTER (HALF CIRCLE) KEY (FACTORY SET TO 125°F).
- 4) THE HIGH LIMIT CONTROL (PROCESS TEMPERATURE SENSING) IN THE PANEL, MOUNTED ON THE BACK PANEL UNDER THE MAIN CONTROLLER TO THE LEFT SIDE, SENSES PROCESS TEMPERATURE AND WILL DISCONNECT POWER TO THE HEATERS IF OVER TEMPERATURE OCCURS. SETPOINT SHOULD BE APPROXIMATELY 20° TO 25°F ABOVE PROCESS TEMPERATURE. WHEN THE TEMPERATURE RETURNS TO BELOW THE HIGH LIMIT SETPOINT THE POWER WILL RETURNED TO THE HEATING CIRCUIT ALLOWING THE HEATERS TO COME ON BUT THE RED HIGH LIMIT RESET PUSHBUTTON WILL BE ILLUMINATED UNTIL MANUALLY RESET (INDICATING THAT THERE WAS A HIGH LIMIT OCCURRENCE). THE CAUSE OF THE MALFUNCTION SHOULD BE INVESTIGATED AT ONCE. POSSIBLE REASONS ARE:
 - Thermocouple failure on the main temperature controller (indicated by “no” in the upper display of the controller).
 - “Over Ranging” of the main temperature controller (indicated by “over” in upper display).
 - Temperature controller setting higher then Hi-Limit controller setting.
 - Main temperature controller out of calibration.
 - Hi-Limit controller out of calibration.
 - Heater magnetic contactor locked in closed position because of “welded” contacts or mechanical binding.

MAINTENANCE

- 1) PERIODICALLY CHECK ALL WIRING CONNECTIONS TO INSURE THEY ARE TIGHT AND FREE OF OXIDATION.
- 2) PERIODICALLY CHECK CONTACTS ON THE CONTACTORS FOR WEAR AND REPLACE CONTACTOR IF WORN.
- 3) CLEANING OF THE HEATER TUBES AND VESSEL IS ACCOMPLISHED BY UNBOLTING FLANGE AND SLIDING TUBE BUNDLE OUT OF VESSEL.

Five Year Warranty

on
Products
Manufactured by
Process Heating Company
PHCo

and delivered to the initial user are subject to the following limited warranty: **PHCo** warrants its Patented Heating Elements to be free from defects in workmanship and materials for a period of five (5) years (one (1) year for drop-in style) after the date of delivery to the initial user when operated under normal use and service and in accordance with printed instructions provided by **PHCo**. All other parts and components provided by **PHCo** as part of the unit are warranted to be free from defects in material and workmanship for a period of one (1) year from date of delivery to the initial user.

THE ABOVE WARRANTY IS SUBJECT TO THE TERMS &
CONDITIONS ON THE REVERSE SIDE OF THIS DOCUMENT

Unless otherwise agreed in writing by Process Heating Company ("PHCo"), all of the following terms & conditions shall apply to its transaction with you (the "buyer"):

1. **LIMITED WARRANTY; DISCLAIMERS.** PHCo warrants that the goods sold under this contract shall be free from defects in workmanship and materials at the time delivery is tendered. If there is discovered any failure of goods to conform to this warranty within one (1) year after tender of delivery (five (5) years in the case of immersion type heating elements other than drop-in style elements), and if Buyer notifies PHCo in writing of such fact within thirty (30) days following such discovery, PHCo at its own expense either will repair the defective item, or replace it, or refund to Buyer the purchase price paid for that item (with choice between repair, replacement or refund to be made solely by PHCo). The foregoing limited warranty and remedy are exclusive of all other warranties, express or implied, and constitute PHCo's exclusive liability, and Buyer's exclusive remedy, on account of any claim relating to any item sold. PHCo DISCLAIMS ANY WARRANTY OF MERCHANTABILITY OR FITNESS FOR ANY PARTICULAR PURPOSE. If PHCo should elect to repair or replace a defective item and if for any reason the repair or replacement should fail in its essential purpose (which is to provide Buyer with a non-defective item), then PHCo's liability nevertheless shall be limited to the purchase price charged by PHCo for the goods. PHCo shall have no liability on account of any claim asserted under principles of negligence or other tort, breach of any statutory duty, indemnity or contribution, or on any other basis, if PHCo's liability on account of such claim would exceed or in any respect differ from its liability under forgoing limited warranty and exclusive remedy.
2. **LIABILITY OF PHCo UNDER THE FOREGOING LIMITED WARRANTY SHALL EXIST ONLY IF:**
 - a. The goods are installed, operated and tested in accordance with the PHCo approved installation and operation instruction.
 - b. The goods are used and maintained in conformity with installation and operation instructions approved or published by PHCo.
 - c. Written authorization must be given by PHCo before any warranty work is done.The above limited warranty shall be void and no longer in effect if the goods are subject to abuse, strain, impact or loading that is greater than their normal.
3. **LIMITATION OF LIABILITY.** UNDER NO CIRCUMSTANCES SHALL PHCO OR ANYONE ELSE INVOLVED IN THE MANUFACTURE OR SALES OF THE GOODS BE LAIBLE TO BUYER OR OTHERS FOR ANY SPECIAL, INCIDENTAL OR CONSEQUENTIAL DAMAGES, INCLUDING BUT NOT LIMITED TO LOST PROFITS, EVEN IF PHCO HAS BEEN ADVISED OF THE POSSIBILITY OF SUCH DAMAGES, OR FOR ANY DAMAGES OR SUMS PAID BY BUYER OR OTHER THIRD PARTIES. THE FOREGOING LIMITATION OF LIABILITY SHALL APPLY WHETHER ANY CLAIM FOR ANY SUCH DAMAGES IS BASED UPON PRINCIPLES OF CONTRACT, WARRANTY, NEGLIGENCE OR OTHER TORT, BREACH OF STATUTORY DUTY, PRINCIPLES OF INDEMNITY OR CONTRIBUTION, THE FAILURE OF ANY LIMITED OR EXCLUSIVE REMEDY TO ACHIEVE ITS ESSENTIAL PURPOSE, OR ANY OTHER BASIS.
4. **AUTHORITY OF PHCo's AGENTS.** No agent, employee or representative of PHCo has any authority to bind PHCo to any other affirmation, representation, promise or warranty concerning the goods sold under this contract, unless it is in writing and included as part of the terms of this contract.
5. **MODIFICATION OF WAIVER.** No subsequent waiver or modification of this Limited Warranty and Liability shall be effective unless the same is in writing and signed by the party against whom such waiver or modification is asserted. No waiver in any one instance shall constitute a waiver of the same or any other term or condition on any subsequent occasion. None of the express terms of this Limited Warranty and Liability may be waived or varied by course of dealing or usage of trade.
6. **DISPUTES.** This agreement shall be governed by the laws of the State of Washington without reference to its choice of law rules. Any action to enforce any of the terms or conditions of this agreement may be commenced or maintained at the option of either party in any federal or state court located in King County, Washington having jurisdiction over the matter, and both parties consent in advance to the exercise by such courts of jurisdiction over them personally. No action by either party arising out of or relating to this contract (including any action based upon principles of contract, tort or otherwise) may be commenced more than one (1) year after the cause of the action has accrued, and any action commenced by a party thereafter shall be dismissed at the instance of the other party.



C Series Temperature Controller Instruction Sheet

Thank you very much for purchasing a Love Controls Series C Temperature Controller. Please read this instruction sheet before using your controller to ensure proper operation and please keep this instruction sheet handy for quick reference.

1 Precaution

⚠ DANGER! Caution! Electric Shock!

1. Do not touch the AC terminals while the power is supplied to the controller to prevent an electric shock.
2. Make sure power is disconnected while checking the unit inside.
3. The symbol  indicates this Controller is protected throughout by DOUBLE INSULATION or REINFORCED INSULATION (equivalent to Class II of IEC 536).





⚠ WARNING!

Mount the controller in a location that will not be subject to excessive temperature, shock, or vibration. All models are designed for mounting in an enclosed panel..

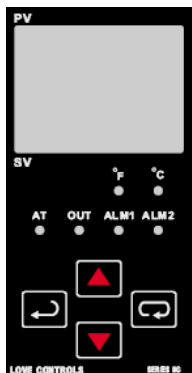
1. Always use recommended solder-less terminals: Fork terminal with isolation (M3 screw, width is 7.0mm, hole diameter 3.2mm). Screw size: M3 x 6.5 (With 6.8 x 6.8 square washer). Recommended tightening torque: 0.4 N.m (4kgf.cm). Applicable wire: Solid/twisted wire of 2 mm², 12AWG to 24AWG. Please be sure to tighten them properly.
2. Do not allow dust or foreign objects to fall inside the controller to prevent it from malfunctioning.
3. Never modify or disassemble the controller.
4. Do not connect anything to the "Not used" terminals.
5. Make sure all wires are connected to the correct polarity of terminals.
6. Do not install and/or use the controller in places subject to: Dust or corrosive gases and liquid, high humidity and high radiation, vibration and shock, high voltage and high frequency
7. Power must be off when wiring and changing a temperature sensor.
8. Be sure to use compensating wires that match the thermocouple types when extending or connecting the thermocouple wires.
9. Please use wires with resistance when extending or connecting a platinum resistance sensor (RTD).
10. Please keep the wire as short as possible when wiring a platinum resistance sensor (RTD) to the controller and please route power wires as far as possible from load wires to prevent interference and induced noise.
11. This controller is an open-type unit and must be placed in an enclosure away from high temperature, humidity, dripping water, corrosive materials, airborne dust and electric shock or vibration.
12. Please make sure power cables and signals from instruments are all installed properly before energizing the controller, otherwise serious damage may occur.
13. Please do not touch the terminals in the controller or try to repair the controller when power is applied to prevent an electric shock.
14. Wait at least one minute after power is disconnected to allow capacitors to discharge, and please do not touch any internal circuit within this period.
15. Do not use acid or alkaline liquids for cleaning. Please use a soft, dry cloth to clean the controller.
16. This instrument is not furnished with a power switch or fuse. Therefore, if a fuse or power switch is required, install the protection close to the instrument. Recommended fuse rating: Rated voltage 250 V, Rated current 1 A. Fuse type: Time-lag fuse
17. Note: This controller does not provide overcurrent protection. Use of this product requires that suitable overcurrent protection device(s) must be added to ensure compliance with all relevant electrical standards and codes. (Rated 250 V, 15 Amps max). A suitable disconnecting device should be provided near the controller in the end-use installation.

2 Display, LED, and Pushbuttons



- PV displays process value
- SV displays setpoint value.
-  INDEX: advances the display to the next menu item.
-  UP ARROW: Increments a value or changes a menu item.
-  DOWN ARROW: Increments a value or changes a menu item.
-  ENTER: stores the value or item change.

3 Temperature Sensor Type and Temperature Range			
Input Temperature Sensor Type	Register Value	LED Display	Temperature Range
Platinum resistance (Pt100) type3	15	Pt3	0.0 to 100.0 °C
Platinum resistance (Pt100) type2	14	Pt2	-20.0 to 500.0 °C
Platinum resistance (Pt100) type1	13	Pt1	-200 to 600 °C
Platinum resistance (JPt100) type2	12	JPt2	0.0 to 100.0 °C
Platinum resistance (JPt100) type1	11	JPt1	-20.0 to 400.0 °C
Thermocouple (TC) B type	10	b	100 to 1800 °C
Thermocouple (TC) S type	9	S	0 to 1700 °C
Thermocouple (TC) R type	8	r	0 to 1700 °C
Thermocouple (TC) N type	7	n	-200 to 1300 °C
Thermocouple (TC) E type	6	E	0 to 600 °C
Thermocouple (TC) T type2	5	t2	-20.0 to 400.0 °C
Thermocouple (TC) T type1	4	t1	-200 to 400 °C
Thermocouple (TC) J type2	3	J2	-20.0 to 400.0 °C
Thermocouple (TC) J type1	2	J1	-100 to 850 °C
Thermocouple (TC) K type2	1	K2	-20.0 to 500.0 °C
Thermocouple (TC) K type1	0	K1	-200 to 1300 °C
Thermocouple (TC) L type	16	L	-200 to 850 °C
Thermocouple (TC) U type	17	U	-200 to 500 °C
Thermocouple (TC) Txx type	18	txx	-200 to 800 °C

4 Operation

There are three modes of operation: operation, regulation and initial setting. When power is applied, the controller will default to the operation mode. Press the key to switch to regulation mode. If the key is pressed for more than 3 seconds, the controller will switch to the initial setting mode. Pressing the key while in the regulation mode or initial setting mode, forces the controller to return to the operation mode. PV/SV : Sets the temperature set point and displays the temperature process value. Use the and keys to set the temperature set point.

Setting method: While in any function mode, press the key to select the desired function and use the and keys to change settings. Press key to save the changes. Menu items are listed below.

Regulation Mode	Operation Mode	Initial Setting Mode
At Auto-tuning (Set in PID control and RUN mode) Press	1234 Use key to set temperature set point Press	tnPt Set input type Press
P Set proportional band (Kp) (in PID control) Press	r-S Control setting RUN or STOP Press	tPUn Set temperature unit do not display when analog input Press
i Set integral time (Ki) (in PID control) Press	AL 1H Upper-limit alarm 1 (This parameter is available only when ALA1 function enables) Press	tP-H Set upper-limit of temperature range Press
d Set derivative time (Kt) (in PID control) Press	AL 1L Lower-limit alarm 1 (This parameter is available only when ALA1 function enables) Press	tP-L Set lower-limit of temperature range Press
PdoF or ioF P/PD control offset (when PID control is ON and Ki=0 set the value of PdoF. If Ki≠0, AT (auto-tuning, will automatically set the value of ioF. Press	AL 2H Upper-limit alarm 2 (This parameter is available only when ALA2 function enables) Press	Ctrl Sets Control Method: on/off, PID, or manual. Press
HES or LES Heating/Cooling hysteresis. (in ON/OFF control) Press	AL 2L Lower-limit alarm 2 (This parameter is available only when ALA2 function enables) Press	S-HC Select heating or cooling control. Press

HtPd or CLPd Heating/Cooling control cycle setting (Set in PID control mode) Press	LoC Setting lock mode Press	ALA1 Alarm 1 mode setting Press
TPoF Regulate temperature deviation value Press	OUT Display and adjust output value. Press	ALA2 Alarm 2 mode setting Press
CrHi Regulate upper-limit of analog output value (The setting display when analog output) Press		CoSH Communication write function enable/disable Press
CrLo Regulate lower-limit of analog output value (The setting display when analog output) Press to return to auto-tuning mode		CoNo Communication address setting Press
		bPS Communication baud rate setting Press
		LEn Data length setting Press
		Prty Parity bit setting Press
		StoP Stop bit setting Press to return input type setting

Parameters List

1. Operation Mode: The default mode after start-up

LED	Explanation	Default
r-S	RUN/STOP: Control setting. Run (rUN) or Stop (StoP) mode on the SV display.	RUN
AL1H	ALARM 1 HIGH: Upper limit for alarm 1. (Only available when alarm is set in the initial setting mode).	4.0 °C
AL1L	ALARM 1 LOW: Lower limit for alarm 1. (Only available when alarm is set in the initial setting mode).	4.0 °C
AL2H	ALARM 2 HIGH: Upper limit for alarm 2. (Only available when alarm is set in the initial setting mode).	4.0 °C
AL2L	ALARM 2 LOW: Lower limit for alarm 2. (Only available when alarm is set in the initial setting mode).	4.0 °C
LoC	Lock Function Setting: LoC1, LoC2, or OFF. LoC1 mode will lock all settings, LoC2 locks everything except the setpoint value, and OFF will not lock any settings. Press and keys simultaneously, to release the lock status.	OFF
OUT	OUT: The Output value adjustment and display in manual tuning control. (Not available in ON/OFF or Auto-tuning control).	0

2. Regulation Mode: Control parameters Settings

LED	Explanation	Default
At	AT (Auto-Tuning): ON or OFF, when set ON, the execution of the auto-tuning function in PID control mode is automatically started. (Only available when PID control is selected in initial settings)	OFF
P	P (Proportional Band in PID control): Sets P value.	47.6
I	I (Integral Time in PID control): Sets I value.	260
D	D (Derivative Time in PID control): Sets D value.	41
PdoF	PdoF: Offset output when P or PD control function is on. PID in initial settings is selected and the value of Ki (Integral Time in regulation mode) is equal to zero.	0
ioF	ioF: Default value of integral volume when PID control is ON and the Ki (Integral Time in regulation mode) is not equal to zero. AT function can automatically set this parameter when PID control is active and Ki≠0.	0
HtS	HtS (Heating Hysteresis): Available only in ON/OFF control. Sets the value the heating hysteresis.	0
CtS	CtS (Cooling Hysteresis): Available only in ON/OFF control. Sets the value the cooling hysteresis.	0
HtPd	HtPd: PID heating control cycle setting. Only available when a PID control is selected in the initial settings.	Output Selection: Voltage: 4 sec. Relay : 20 sec.
CLPd	CLPd: PID cooling control cycle setting. Only available when a PID control is selected in the initial settings.	
TPoF	TPoF: Regulates the temperature deviation value.	0
CrHi	CrHi: Regulates the 20 mA output deviation value.	0
CrLo	CrLo: Regulates the 4 mA output deviation value.	0
LoC	HtS (Heating Hysteresis): Available only in ON/OFF control. Sets the value the heating hysteresis.	0

3. Initial Setting Mode: Initial settings of the controller and communication parameters

LED	Explanation	Default
INPt	INPUT: Select input temperature sensor type (Please refer to the contents of the "Temperature Sensor Type and Temperature Range" for detail)	PT2
EPUn	Engineering Unit(°F or °C): Select engineering unit F or C.	°C
EP-H	T-High: Upper limit for temperature range.	500.0
EP-L	T-Low: Lower limit for temperature range.	-20.0
Ctrl	CONTROL METHOD (ON/OFF, PID, or manual tuning [MANU]): Sets the control method for the set point value.	PID
S-HC	Control Action (Direct or Reverse Acting): Cooling [Cool] or heating [HEAT].	HEAT
ALR1	ALARM 1: Alarm 1 setting. (See Alarm Output Section for set values and descriptions).	0
ALR2	ALARM 2: Alarm 2 setting. (See Alarm Output Section for set values and descriptions).	0
COSh	C WE: Write-in function disabled/enabled. Can be set only when unit is equipped with serial communication.	OFF
C-no	C NO: Address setting. Can be set only when unit is equipped with serial communication.	1
bPS	BPS: Baud rate setting. Can be set only when unit is equipped with serial communication.	9600
LEN	Length: Data length setting. Can be set only when unit is equipped with serial communication.	7
ParTy	Parity: Parity bit setting. Can be set only when unit is equipped with serial communication.	E
StoP	Stop Bit: Stop bit setting. Can be set only when unit is equipped with serial communication.	1

Execution :

The programming execution is initiated through **r-S** in the operation mode.

When **r-S** is set to **run**, the program will start to execute in order from the step 0 of the start pattern.

When **r-S** is set to **StoP**, the program will stop and the control output is disabled

5 Heating and Cooling

Temperature control can be achieved either by heating or cooling. Please refer to the following for the operation: Settings for heat or cool operation are found in the initial settings mode under **S-HC**.

Select **HEAT**, for heating (reverse) control on Output 1.

Select **Cool**, for cooling (forward) control on Output 1





Input Error Indication

Setting value	Temperature sensor is not connected	Measured temperature value exceeds the temperature range	Unknown input
PV	no	ouEr	Err
SV	Cont		INPt

6 Alarm Outputs

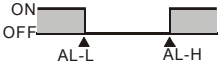
Depending on the controller model, there can be up to two alarm outputs. Each alarm output can be configured for an alarm type listed below. Alarm types are set in the initial setting mode. The alarm output is activated whenever the process temperature value (PV) is getting higher or lower than the set point of alarm limit.

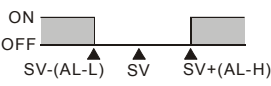
Set Value	Alarm Type	Alarm Output Operation
0	Alarm function disabled	Output OFF
1	Deviation upper- and lower-limit: This alarm output operates when PV value is higher than the setting value SV+(AL-H) or lower than the setting value SV-(AL-L).	
2	Deviation upper-limit: This alarm output operates when PV value is higher than the setting value SV+(AL-H).	
3	Deviation lower-limit: This alarm output operates when PV value is lower than the setting value SV-(AL-L).	
4	Reverse deviation upper- and lower-limit: This alarm output operates when PV value is in the range of the setting value SV+(AL-H) and SV-(AL-L).	

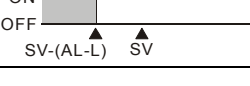
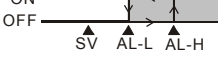
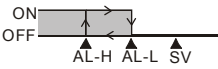
5	Absolute value upper- and lower-limit: This alarm output operates when PV value is higher than the setting value AL-H or lower than setting value AL-L.	
6	Absolute value upper-limit: This alarm output operates when PV value is higher than the setting value AL-H.	
7	Absolute value lower-limit: This alarm output operates when PV value is lower than the setting value AL-L.	
8	Deviation upper- and lower-limit with standby sequence: This alarm output operates when PV value reaches set point (SV value) and the value is higher than the setting value SV+(AL-H) or lower than the setting value SV-(AL-L).	
9	Deviation upper-limit with standby sequence: This alarm output operates when PV value reaches set point (SV value) and the reached value is higher than the setting value SV+(AL-H).	
10	Deviation lower-limit with standby sequence: This alarm output operates when PV value reaches the set point (SV value) and the reached value is lower than the setting value SV-(AL-L).	
11	Hysteresis alarm output: Heating control: This alarm output operates if PV value is higher than the setting value SV+(AL-H). This alarm output is OFF when PV value is lower than the setting value SV+(AL-L).	
12	Hysteresis alarm output: Cooling control: This alarm output operates if PV value is lower than the setting value SV-(AL-H). This alarm output is OFF when PV value is higher than the setting value SV-(AL-L).	

(Note: AL-H and AL-L include AL1H, AL2H and AL1L, AL2L)

With the standby sequence, the alarm output will be temporarily disabled until the PV value reaches the set value. Then, the alarm output will operate. Once the alarming output operation is activated, there is a 1.5 sec. delay time to avoid any malfunction.

7 Specification

Input Voltage	100 to 240VAC 50/60Hz
Operation Voltage Range	85% to 110% of rated voltage
Power Consumption	5VA max.
Memory Protection	EEPROM 4K bit (non-volatile memory (number of writes: 100,000))
Display Method	2 line x 4 character 7-segment LED display Process value(PV): Red color, Set point(SV): Green color
Sensor Type	Thermocouple: K, J, T, E, N, R, S, B, L, U, TXK 3-wire Platinum RTD: Pt100, JPt100
Control Mode	PID, ON/OFF, Manual or Auto-tuning.
Control Output	Relay output: SPDT (SPST on the 1/16 DIN size series16C), Max. load 250VAC, 5A resistive load Voltage pulse output: DC 14V, Max. output current 40mA Current output: DC 4 ~ 20m A output (Load resistance: Max. 600Ω)
Display Accuracy	0.1% of measuring range.
Sampling Rate	0.5 sec.
RS-485 Communication	MODBUS ASCII communication protocol (only on models designated with serial communication).
Vibration Resistance	10 to 55Hz, 10m/s ² for 10min, each in X, Y and Z directions
Shock Resistance	Max. 300m/ s ² , 3 times in each 3 axes, 6 directions
Ambient Temperature	32 °F to 122 °F (0 °C to +50 °C)
Storage Temperature	-4 °F to 150 °F (-20 °C to +65 °C)
Altitude	2000m or less
Relative Humidity	0% to 80% (non-condensing)

Panel Cutout [dimensions are in mm (in.)]

Terminals Identification

16C		
8C		
4C		

Dimensions are in millimeter (inch)

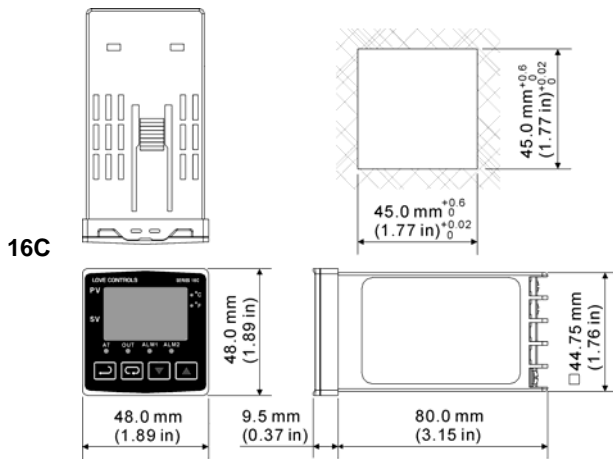
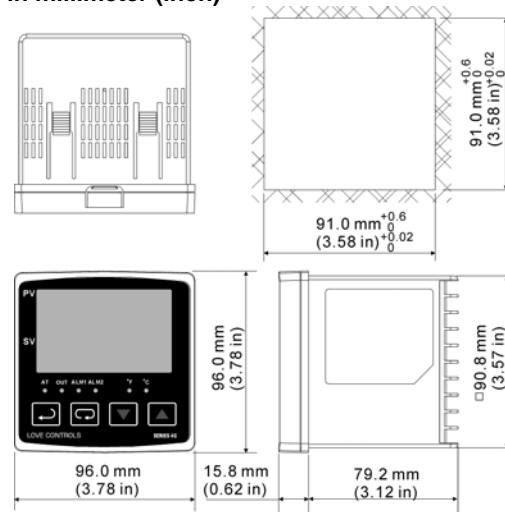
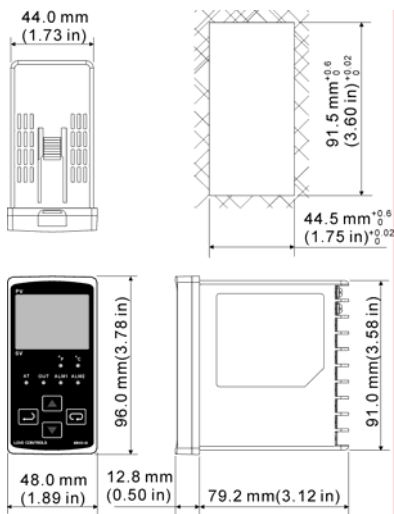
**4C****8C****Mounting Method**

- Step 1: Insert the controller through the panel cutout.
- Step 2: Insert the mounting bracket into the mounting groove at the top and bottom of the controller
- Step 3: Push the mounting bracket forward until the bracket stops at panel wall.
- Step 4: Insert and tighten screws on bracket to secure the controller in place. (The screw torque should be 0.8kgf-cm to 1.5kgf-cm)

16C/8C/4C Mounting Method:

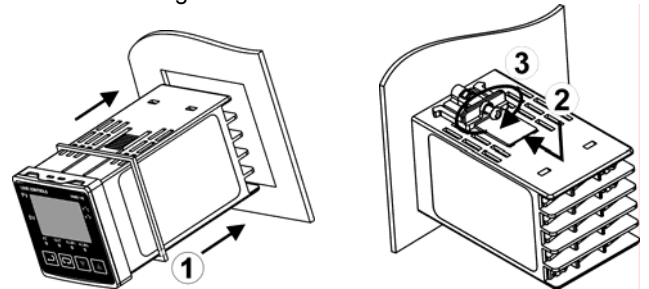
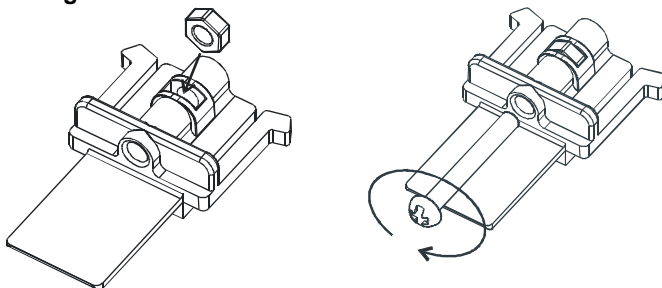
**Mounting Bracket Installation**

120L-17JZ333

PRODUCT SPECIFICATION SHEET

MODEL: **120L-17JZ333**
REV: -

DESCRIPTION: DIN Rail/Surface Mtg. Temp Limit Controller	CUSTOMER PN: Process Heating	DATE: 10/17/06
--	--	--------------------------

Input Voltage: 115VAC ±15%, 50/60Hz, 3VA Max.
Control Output: SPDT Relay, N.O. contacts rated 8 Amps Res. 240VAC, 100,000 cycles
Control Mode: Relay de-energizes on temperature rise (N.O. contacts open).
Control Action: Latching with manual reset (Reset terminals open) or On-Off with 2°F Hyst. (Reset terminals shorted) .
Manual Reset: Cycle power off & on or momentarily short Reset terminals with N.O. momentary switch (customer supplied).
Set Point Range: 0 to 300°F
Setpoint Adj.: Local SP pot with dual °F/°C graduated scales
Sensor Type: "J" Thermocouple
Compensation: Automatic cold junction compensation
Control Stability: Typically better than ±5mV/°F ambient and .01% of span/% rated line voltage
Set Point Accuracy: ±3% of FS maximum at 25°C and rated line voltage
Sensor Failure Prot: Contacts open for thermocouple break
Amb. Oper. Temp: 0 to 55°C (32 to 131°F)

MECHANICAL

Enclosure Material: Noryl, Black color
Field Terminations: Screw termininals with wire clamping plates and touch safe shield.
Mounting: 35mm DIN rail and surface mounting base

AGENCY APPROVALS UL 873 & CUL per CSA C22.2 No. 24 File #E105669

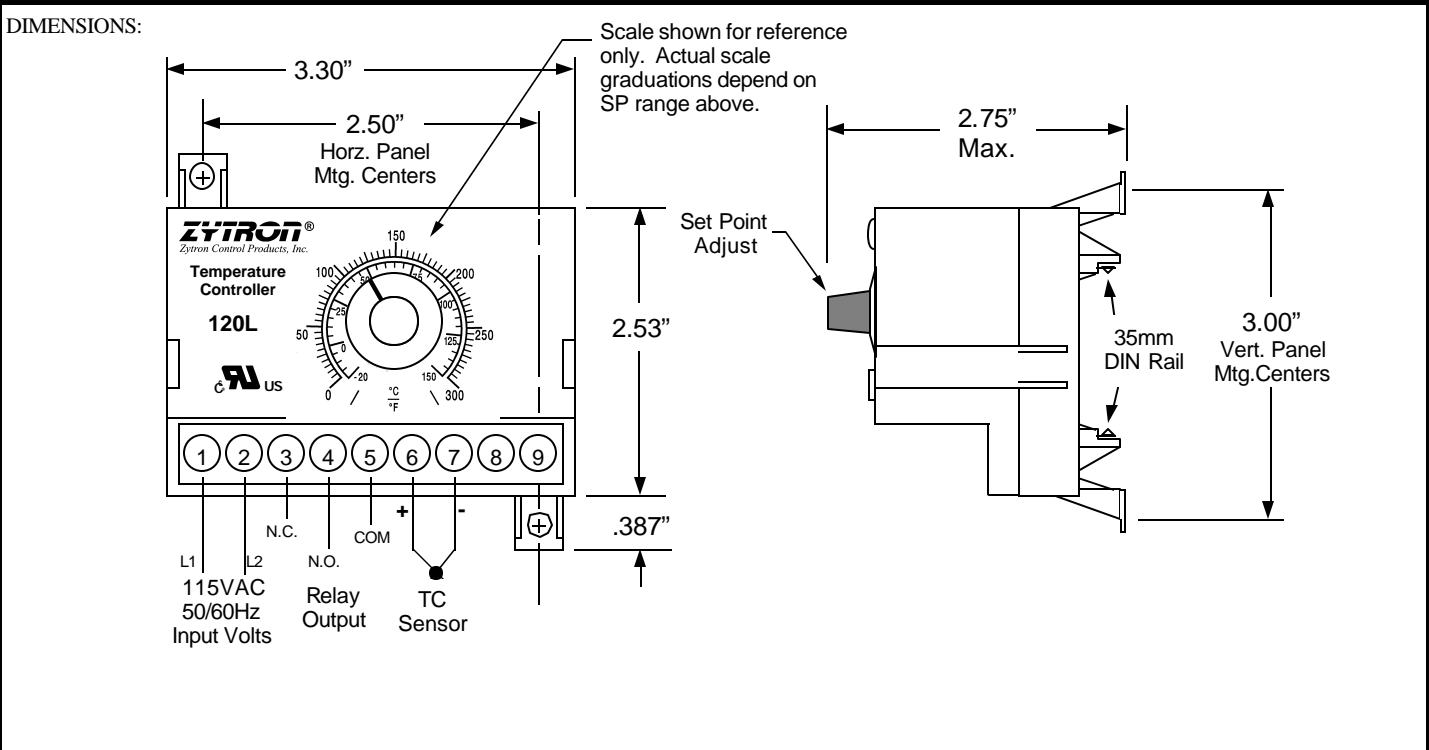

LTR	DESCRIPTION	DATE



Industrial Control Transformer Transformador de control industrial Transformateur de contrôle industriel

Class	Type
Clase	Tipo
Classe	Type
9070	T, TF

Retain for future use. / Conservar para uso futuro. / À conserver pour usage ultérieur.

RECEIVING

Inspect the transformer for damage. If damaged, notify and file a claim with the carrier. Contact the supplier for repair or replacement.

RECIBO

Realice una inspección visual del transformador para ver si encuentra daños. Si ha encontrado daños, notifique a la compañía de transportes y presente una reclamación. Comuníquese con el proveedor para obtener detalles sobre la reparación o sustitución del equipo.

RÉCEPTION

Inspecter le transformateur pour rechercher les dommages. En cas de dommage, prière d'aviser l'entreprise de transport et de faire une déclaration auprès de celle-ci. Contacter le fournisseur pour les réparations ou le remplacement.

PRECAUTIONS

PRECAUCIONES

PRÉCAUTIONS

⚠ DANGER / PELIGRO / DANGER

HAZARD OF ELECTRIC SHOCK, EXPLOSION, OR ARC FLASH

- Apply appropriate personal protective equipment (PPE) and follow safe electrical work practices. See NFPA 70E.
- This equipment must only be installed and serviced by qualified electrical personnel in accordance with the National Electrical Code® (NEC®) and any other applicable codes or standards.
- Turn off all power supplying this equipment before working on or inside equipment.
- Always use a properly rated voltage sensing device to confirm power is off.
- Replace all devices, doors and covers before turning on power to this equipment.

Failure to follow these instructions will result in death or serious injury.

PELIGRO DE DESCARGA ELÉCTRICA, EXPLOSIÓN O DESTELLO POR ARQUEO

- Utilice equipo de protección personal (EPP) apropiado y siga las prácticas de seguridad eléctrica establecidas por su Compañía, consulte la norma 70E de NFPA.
- Solamente el personal eléctrico especializado deberá instalar y prestar servicio de mantenimiento a este equipo de acuerdo con las normas del Código nacional eléctrico de los EUA (NEC®) o NOM-001-SEDE así como con cualquier otra norma y código local correspondiente.
- Desenergice el equipo antes de realizar cualquier trabajo en él.
- Siempre utilice un dispositivo detector de tensión nominal adecuado para confirmar la desenergización del equipo.
- Vuelva a colocar todos los dispositivos, las puertas y las cubiertas antes de volver a energizar el equipo.

El incumplimiento de estas instrucciones podrá causar la muerte o lesiones serias.

RISQUE D'ÉLECTROCUTION, D'EXPLOSION OU D'ÉCLAIR D'ARC

- Portez un équipement de protection personnelle (ÉPP) approprié et observez les méthodes de travail électrique sécuritaire. Voir NFPA 70E.
- Seul un personnel qualifié doit effectuer l'installation et l'entretien de cet appareil conformément au Code National de l'Électricité (NEC®, É.-U.) et tout autre code et norme applicables.
- Coupez l'alimentation de l'appareil avant d'y travailler.
- Utilisez toujours un dispositif de détection de tension ayant une valeur nominale appropriée pour s'assurer que l'alimentation est coupée.
- Remplacez tous les dispositifs, les portes et les couvercles avant de mettre l'appareil sous tension.

Si ces directives ne sont pas respectées, cela entraînera la mort ou des blessures graves.

1. On the nameplate, verify that the transformer kVA and voltage are correct for the line and load.

Continued on next page

1. Consulte la placa de datos y verifique que los kVA y tensión del transformador sean los correctos para la línea y carga.

Continúa en la siguiente página

1. Sur la plaque signalétique, vérifiez si les kVA et la tension du transformateur sont corrects pour la ligne et la charge.

Page suivante

2. Install the transformer only in a well-ventilated area that is free from explosive or corrosive gases, vapor, or excessive dust, dirt, and moisture.
3. Ensure a free flow of air around the transformer. Do not exceed surrounding air temperature of 40° C (104° F).
4. Use sufficient mounting hardware to support the weight of the transformer.

PROTECTION

Use fuses or circuit breakers in accordance with Article 450 of the National Electrical Code® (NEC®) and any other applicable codes and standards.

- For Type TF fusing, use only Class CC rejection fuses on the primary.
- If high voltage transients are possible, use appropriate surge suppression.

ACCESSORIES

To meet European Normalized (EN) Standards, use terminal covers (not included). Refer to the transformer section in the Schneider Electric *Digest*, and call 1-888-778-2733 for accessory information.

CONNECTION AND INSTALLATION

2. Instale el transformador sólo en un área bien ventilada libre de gases explosivos y corrosivos, vapor o demasiado polvo, suciedad y humedad.
3. Asegúrese de que circule el aire alrededor del transformador y de que no exceda la temperatura ambiente de 40° C (104° F).
4. Utilice suficiente herrajes de montaje para soportar el peso del transformador.

PROTECCIÓN

Utilice los fusibles o interruptores automáticos necesarios para cumplir con los requisitos del artículo 450 del Código nacional eléctrico de EUA (NEC®) o NOM-001-SEDE así como con otras normas y códigos locales correspondientes.

- Para las unidades tipo TF, utilice sólo fusibles de rechazo clase CC en el primario.
- Utilice supresores de transitorios apropiados si existe la posibilidad de sobretensiones transitorias.

ACCESORIOS

Para cumplir con las normas europeas (EN), utilice las cubiertas de terminales (no provistas). Consulte la sección de transformadores en el *Compendiado* de Schneider Electric y llame al 1-888-778-2733 (en los EUA) para obtener información sobre los accesorios.

CONEXIÓN E INSTALACIÓN

2. Installer le transformateur seulement dans une zone bien ventilée, dépourvue de gaz ou de vapeur explosif ou corrodant, ou de poussière, de saletés et d'humidité excessives.
3. Assurer une circulation libre de l'air autour du transformateur. Ne pas dépasser une température ambiante de 40° C (104° F).
4. Utiliser la quincaillerie de montage suffisante pour supporter le poids du transformateur.

PROTECTION

Utiliser les fusibles ou les disjoncteurs conformément à l'article 450 du Code national de l'électricité (NEC®, É.-U.) et à tout autre code ou norme applicable.

- Pour les unités type TF, utiliser uniquement des fusibles class CC avec dispositif de rejet sur le primaire.
- Si des tensions transitoires élevées sont possibles, utiliser une suppression de surtension appropriée.

ACCESSOIRES

Pour satisfaire aux normes européennes (NE), utiliser des couvercles de bornes (non fournis). Se reporter à la section des transformateurs dans le *Digest* Schneider Electric, et appeler le 1-888-778-2733 (É.-U.) pour obtenir des informations concernant les accessoires.

CONNEXION ET INSTALLATION

⚠ DANGER / PELIGRO / DANGER		
<p>HAZARDOUS VOLTAGE</p> <p>Turn off power before installing or servicing.</p> <p>Failure to follow this instruction will result in death or serious injury.</p>	<p>TENSIÓN PELIGROSA</p> <p>Desconecte la alimentación antes de instalar o prestarle servicio.</p> <p>El incumplimiento de esta instrucción podrá causar la muerte o lesiones serias.</p>	<p>TENSION DANGEREUSE</p> <p>Coupez l'alimentation avant d'installer ou de procéder à l'entretien.</p> <p>Si cette directive n'est pas respectée, cela entraînera la mort ou des blessures graves.</p>

- | | | |
|--|---|---|
| <p>1. If necessary, install jumpers to obtain input and/or output voltages. If windings are tapped, do not use jumpers.</p> <ul style="list-style-type: none"> — Figure 1 on page 4 shows a <i>typical parallel</i> connection to obtain the lower of the two possible voltages. On the primary side, connect one jumper to H1 and H3 and one to H2 and H4. On the secondary side, connect one jumper to X2 and X4 and one to X1 and X3. — Figure 2 on page 4 shows <i>typical series</i> connection to obtain the higher of the two possible voltages. On primary side, connect both jumpers to H2 and H3. On secondary side, connect both jumpers to X2 and X3. See the nameplate wiring diagram for connections. <p>2. Connect only the primary according to the nameplate wiring diagram (A).</p> <p>3. Energize the transformer. Measure the secondary voltage to ensure transformer voltages are correct for the load.</p> <p>4. Turn off the primary supply, and connect the load to the secondary terminals (B). All terminals are not always used. See the nameplate wiring diagram.</p> <p>5. Tighten all unused screws. Torque the remaining screws as follows:</p> <ul style="list-style-type: none"> — 6–32 screw
7–9 lbs-in (0.8–1.0 N•m) — 8–32 screw
14–16 lb-in (1.6–1.8 N•m) — 10–24 screw
17–19 lb-in (1.9–2.2 N•m) <p>6. If applicable, install the covers.</p> <p>7. Energize the transformer.</p> | <p>1. Si es necesario, instale puentes de conexión para obtener tensiones de entrada y/o salida. Si los devanados tienen derivaciones, no utilice puentes de conexión.</p> <ul style="list-style-type: none"> — La figura 1 en la página 4 muestra una conexión <i>paralela típica</i> para obtener la tensión más baja posible de las dos. En el lado del primario, conecte un puente a H1 y H3 y el otro puente a H2 y H4. En el lado del secundario, conecte un puente a X2 y X4 y el otro puente a X1 y X3. — La figura 2 en la página 4 muestra una conexión en <i>serie típica</i> para obtener la tensión más alta posible de las dos. En el lado del primario, conecte ambos puentes a H2 y H3. En el lado del secundario, conecte ambos puentes a X2 y X3. Consulte el diagrama de alambrado en la placa de datos para realizar las conexiones. <p>2. Conecte solamente el primario según el diagrama de alambrado en la placa de datos (A).</p> <p>3. Energice el transformador. Mida la tensión secundaria y asegúrese de que las tensiones del transformador sean las correctas para la carga.</p> <p>4. Desconecte la fuente de alimentación del primario y conecte la carga a las terminales del secundario (B). No siempre se usan todas las terminales. Consulte el diagrama de alambrado en la placa de datos.</p> <p>5. Apriete todos los tornillos sin usar. Apriete el resto de los tornillos de la siguiente manera:</p> <ul style="list-style-type: none"> — Tornillo 6–32
0,8–1,0 N•m (7–9 lbs-pulg) — Tornillo 8–32
1,6–1,8 N•m (14–16 lbs-pulg) — Tornillo 10–24
1,9–2,2 N•m (17–19 lbs-pulg) <p>6. Si fuese aplicable, instale las cubiertas.</p> <p>7. Energice el transformador.</p> | <p>1. Si nécessaire, installer des cavaliers pour obtenir les tensions d'entrée ou de sortie. Si les enroulements sont munis de prises, ne pas utiliser de cavaliers.</p> <ul style="list-style-type: none"> — La figure 1 à la page 4 indique la connexion <i>parallèle typique</i> pour obtenir la tension la plus faible des deux tensions possibles. Sur le côté primaire, connecter un cavalier entre H1 et H3 et un autre entre H2 et H4. Sur le côté secondaire, connecter un cavalier entre X2 et X4 et un autre entre X1 et X3. — La figure 2 à la page 4 indique la connexion <i>en série typique</i> pour obtenir la tension la plus élevée des deux tensions possibles. Sur le côté primaire, connecter les deux cavaliers entre H2 et H3. Sur le côté secondaire, connecter les deux cavaliers entre X2 et X3. Voir le schéma de câblage de la plaque signalétique pour obtenir les connexions. <p>2. Connecter seulement le primaire conformément au schéma de câblage de la plaque signalétique (A).</p> <p>3. Mettre le transformateur sous tension. Mesurer la tension secondaire pour s'assurer que les tensions du transformateur correspondent à la charge.</p> <p>4. Couper l'alimentation primaire et connecter la charge aux bornes secondaires (B). Les bornes ne sont pas toujours toutes utilisées. Voir le schéma de câblage de la plaque signalétique.</p> <p>5. Serrer toutes les vis non utilisées. Serrer les autres vis aux couples suivants :</p> <ul style="list-style-type: none"> — Vis 6–32
0,8 à 1,0 N•m (7 à 9 lb-po) — Vis 8–32
1,6 à 1,8 N•m (14 à 16 lb-po) — Vis 10–24
1,9 à 2,2 N•m (17 à 19 lb-po) <p>6. Le cas échéant, installer les couvercles.</p> <p>7. Mettre le transformateur sous tension.</p> |
|--|---|---|

MAINTENANCE

1. De-energize the transformer.
2. Check for loose connections and wiring, or lead deterioration. Tighten, insulate, or replace where necessary.

SERVICIO DE MANTENIMIENTO

1. Desenergice el transformador.
2. Realice una inspección para ver si encuentra conexiones y cables sueltos, o conductores dañados. Apriete las conexiones, aisle o reemplace los cables o conductores que sean necesarios.

ENTRETIEN

1. Mettre le transformateur hors tension.
2. Rechercher les connexions et les câbles desserrés, ou les conducteurs endommagés. Serrer les connexions, isoler ou remplacer les câbles ou conducteurs lorsque nécessaire.

Figure / Figura / Figure 1 : Typical parallel connection /
Conexión paralela típica /
Connexion parallèle typique

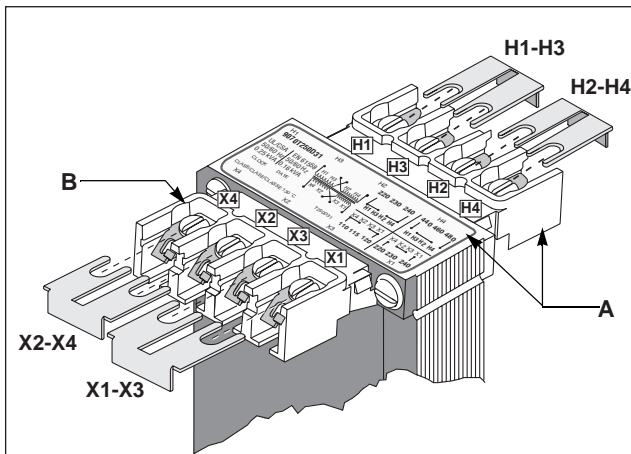
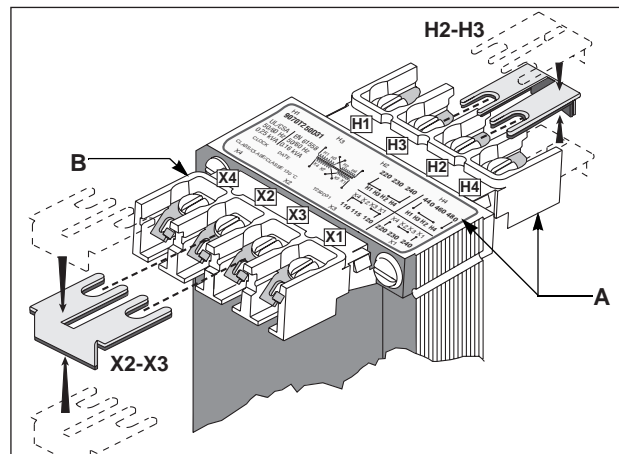

Figure / Figura / Figure 2 : Typical series connection /
Conexión en serie típica /
Connexion en série typique



Electrical equipment should be installed, operated, serviced, and maintained only by qualified personnel. No responsibility is assumed by Schneider Electric for any consequences arising out of the use of this material.

Schneider Electric USA
6 Commercial Road
Huntington, IN 46750 USA
1-888-SquareD (1-888-778-2733)
www.us.SquareD.com

Solamente el personal especializado deberá instalar, hacer funcionar y prestar servicios de mantenimiento al equipo eléctrico. Schneider Electric no asume responsabilidad alguna por las consecuencias emergentes de la utilización de este material.

Importado en México por:
Schneider Electric México, S.A. de C.V.
Calz. J. Rojo Gómez 1121-A
Col. Gpe. del Moral 09300 México, D.F.
Tel. 55-5804-5000
www.schneider-electric.com.mx

Seul un personnel qualifié doit effectuer l'installation, l'utilisation, l'entretien et la maintenance du matériel électrique. Schneider Electric n'assume aucune responsabilité des conséquences éventuelles découlant de l'utilisation de cette documentation.

Schneider Electric Canada
19 Waterman Avenue, M4B 1 Y2
Toronto, Ontario
1-800-565-6699
www.schneider-electric.ca

Notes

Process Heating Company, Inc.

With Over Fifty Years of Designing & Manufacturing Lo-Density Automatic Electric Heating Systems

